

⊕ 3 ⊕

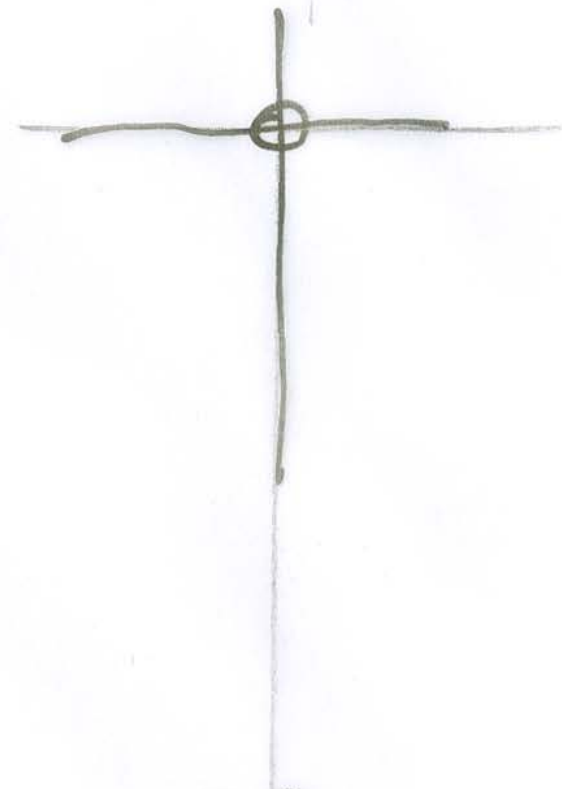

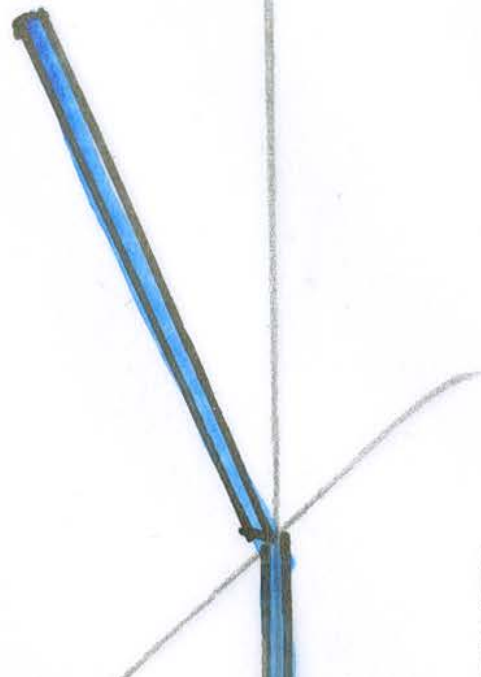

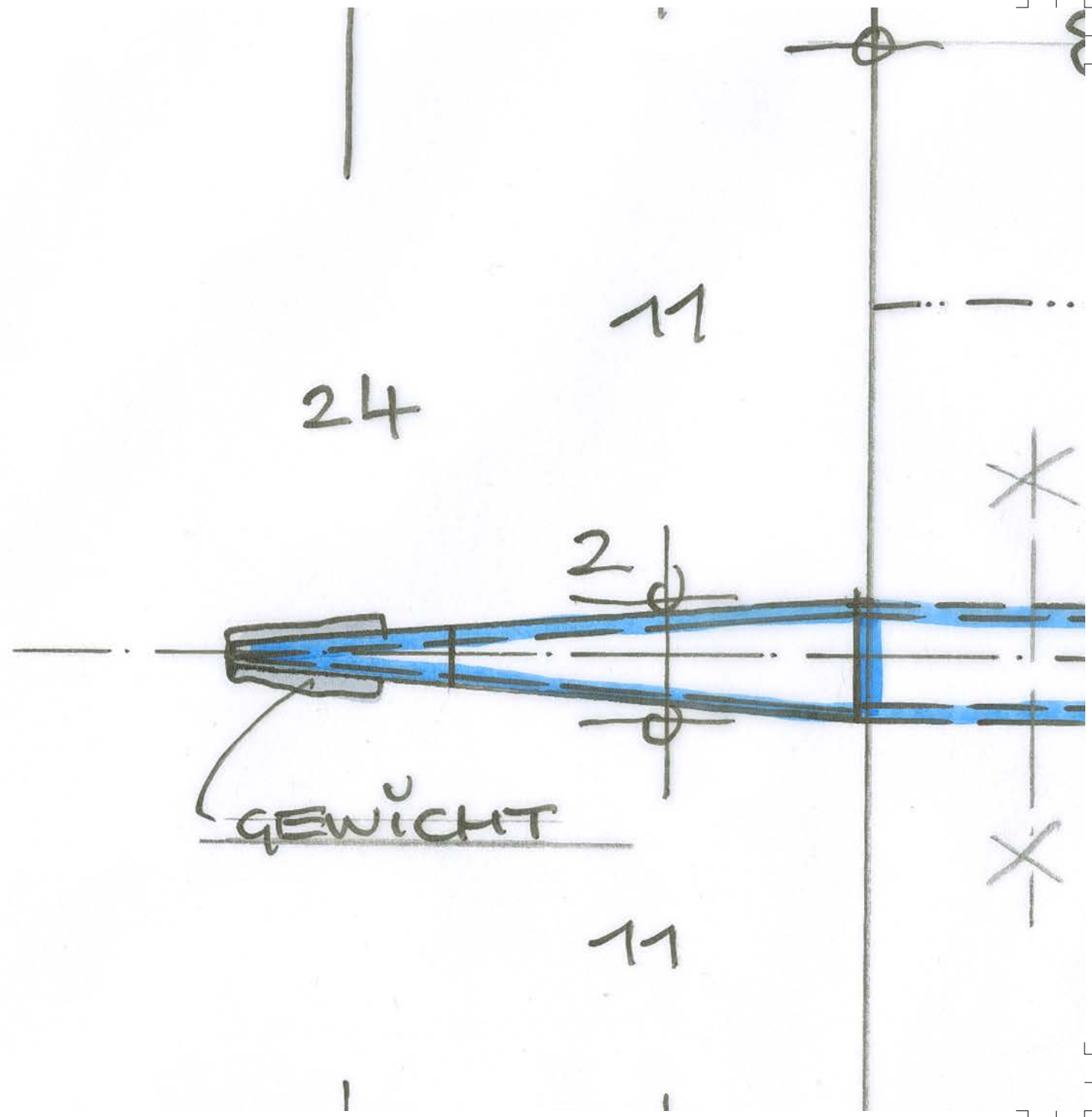

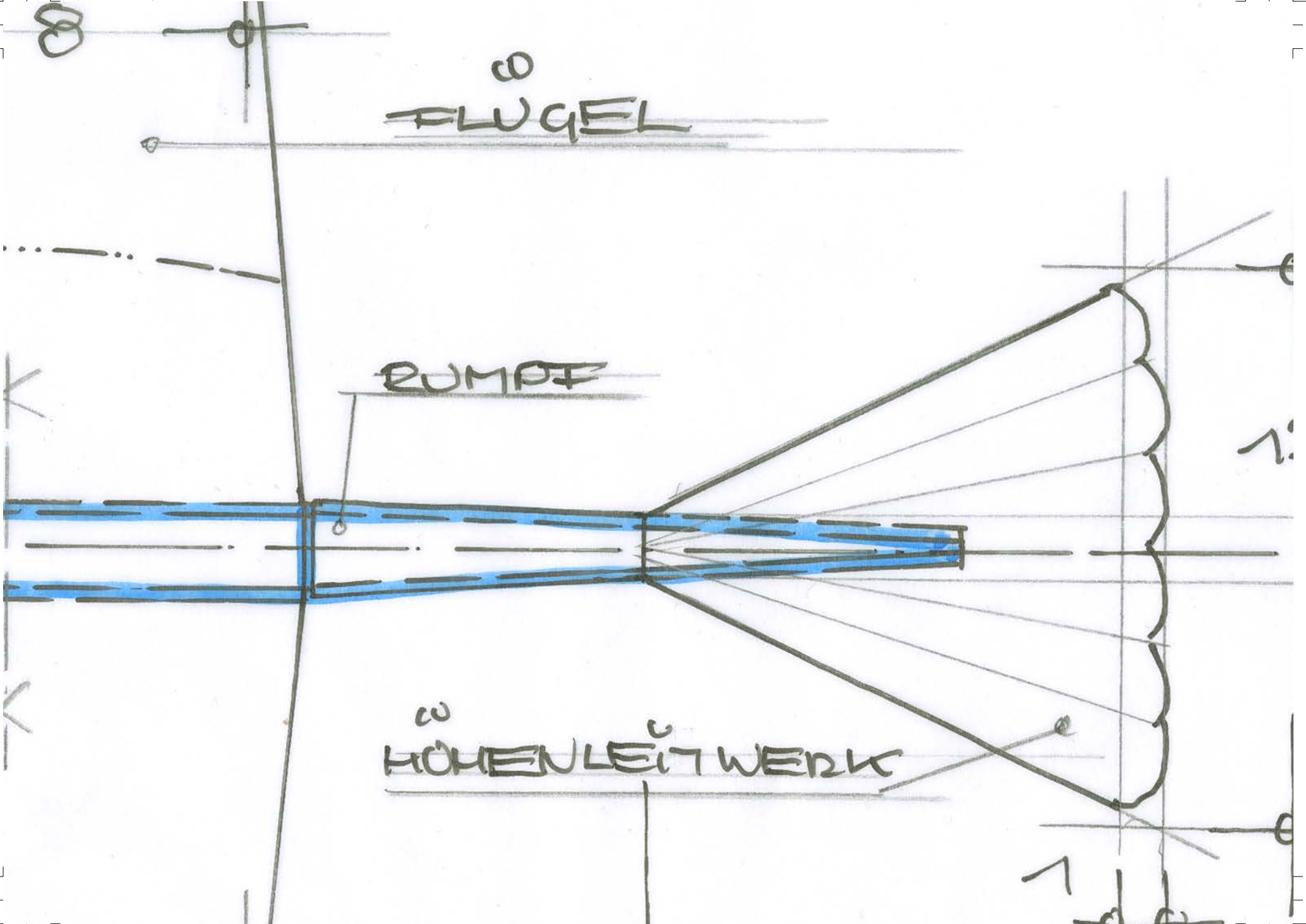

ω
FLUGEL

RUMPF

ω
HÖHENLEITWERK

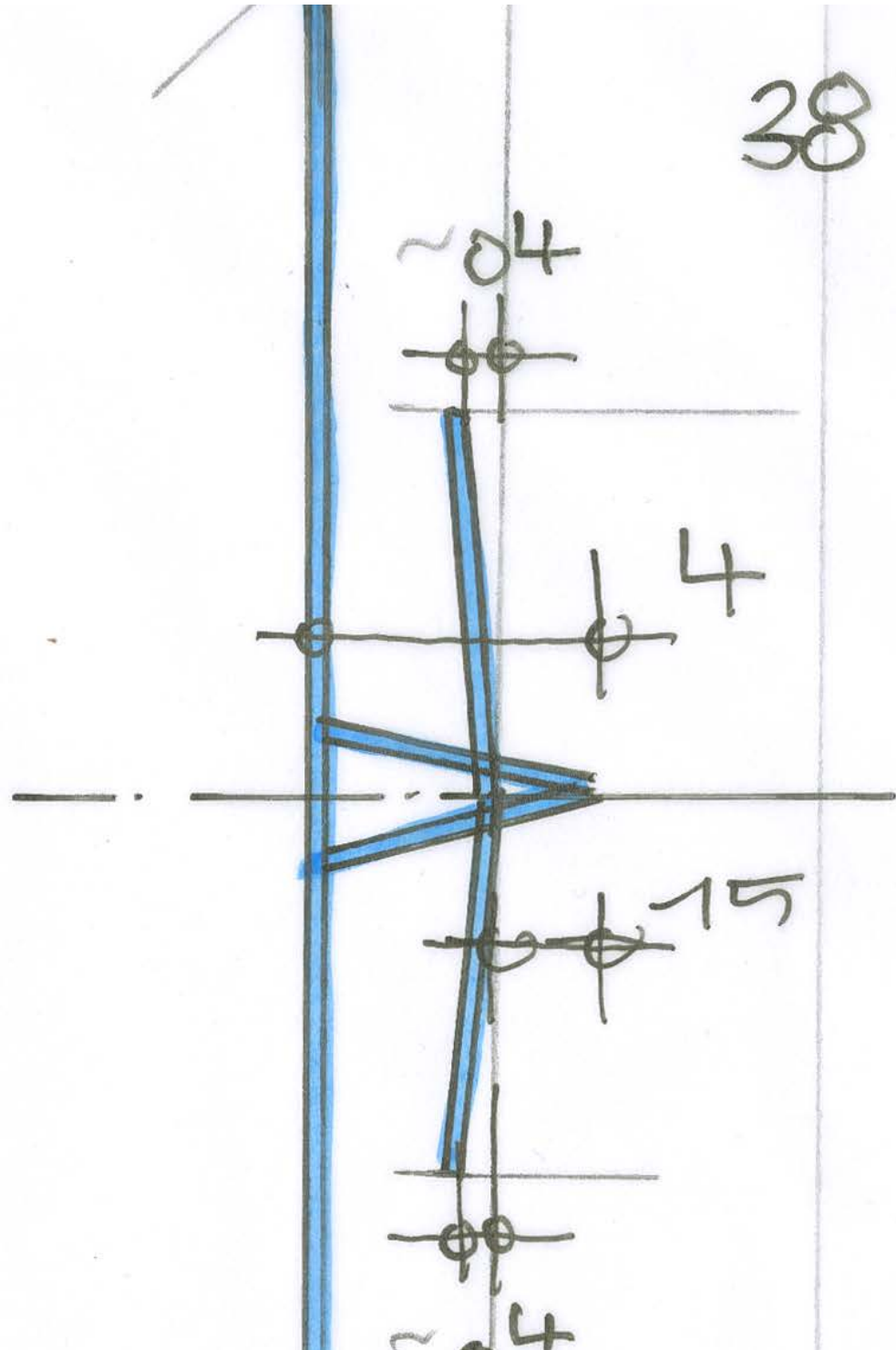
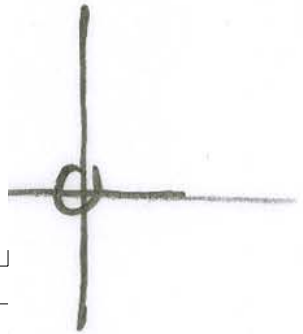
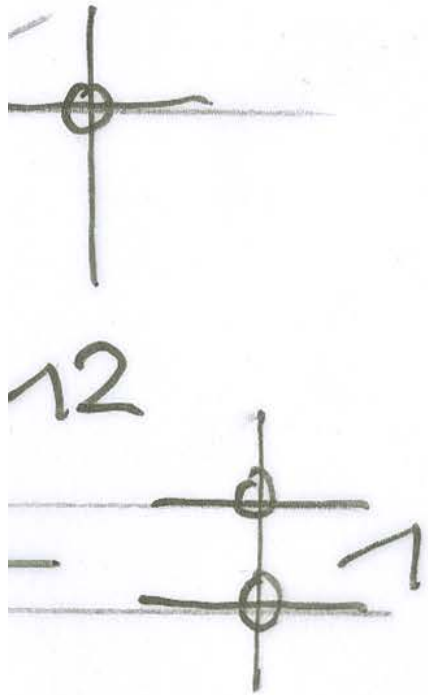



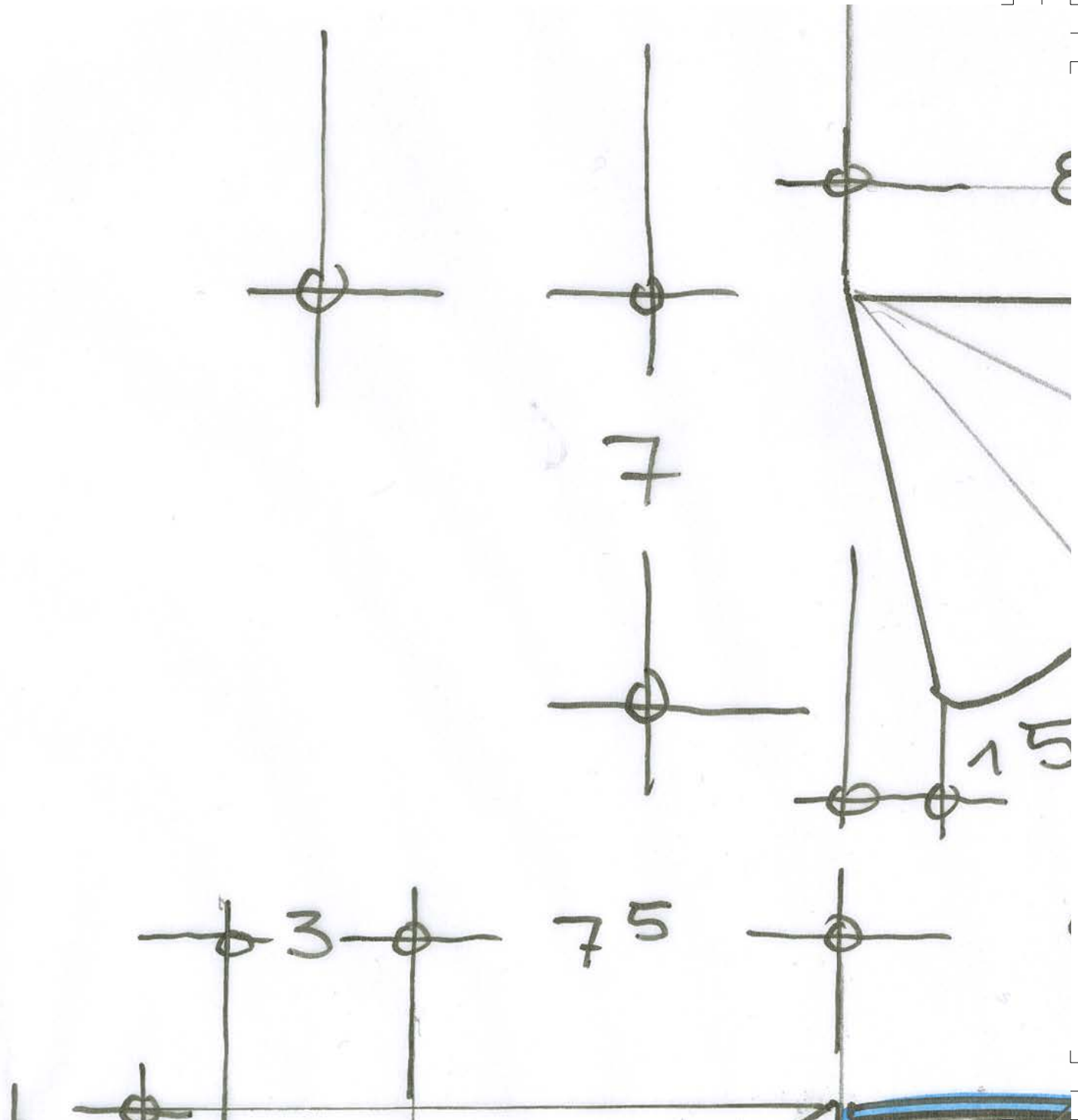

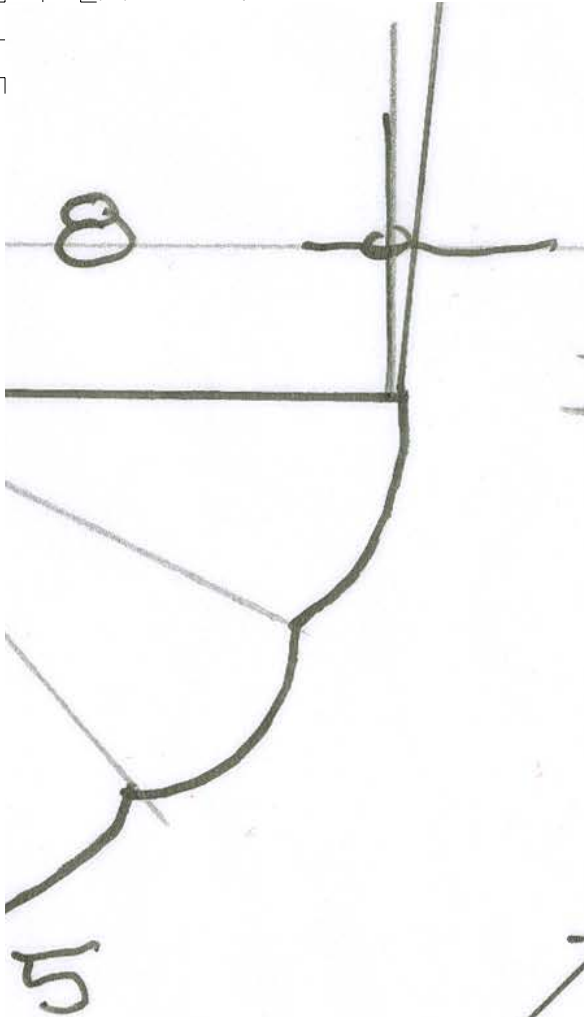

AUFSICHT

BALANCEPUNKT

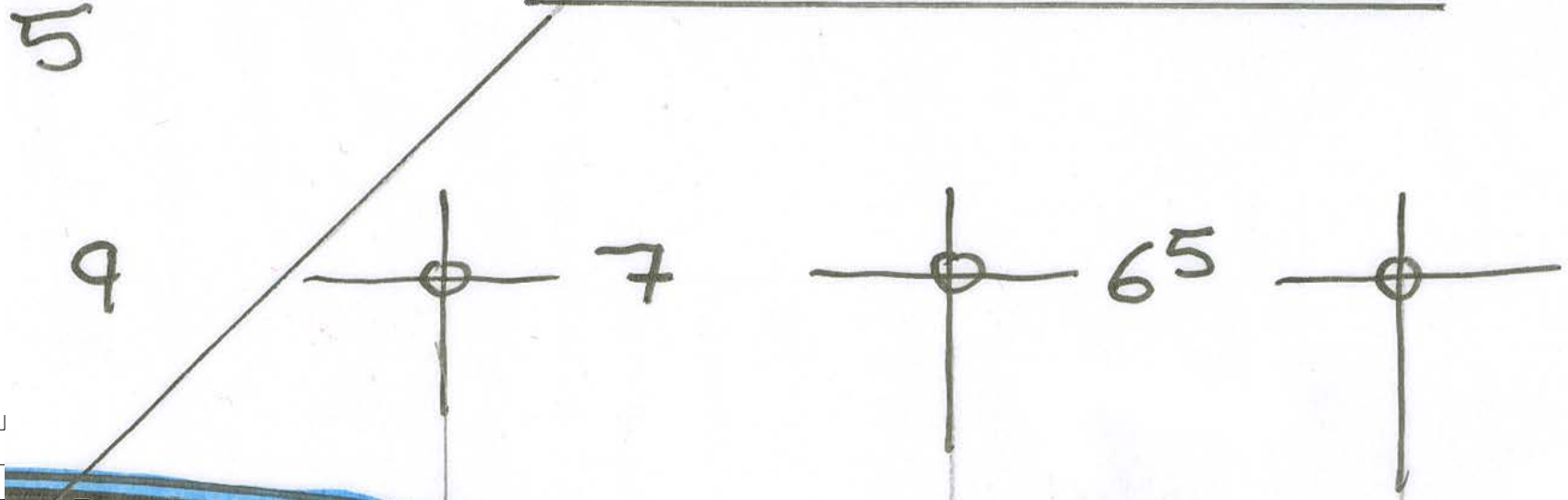

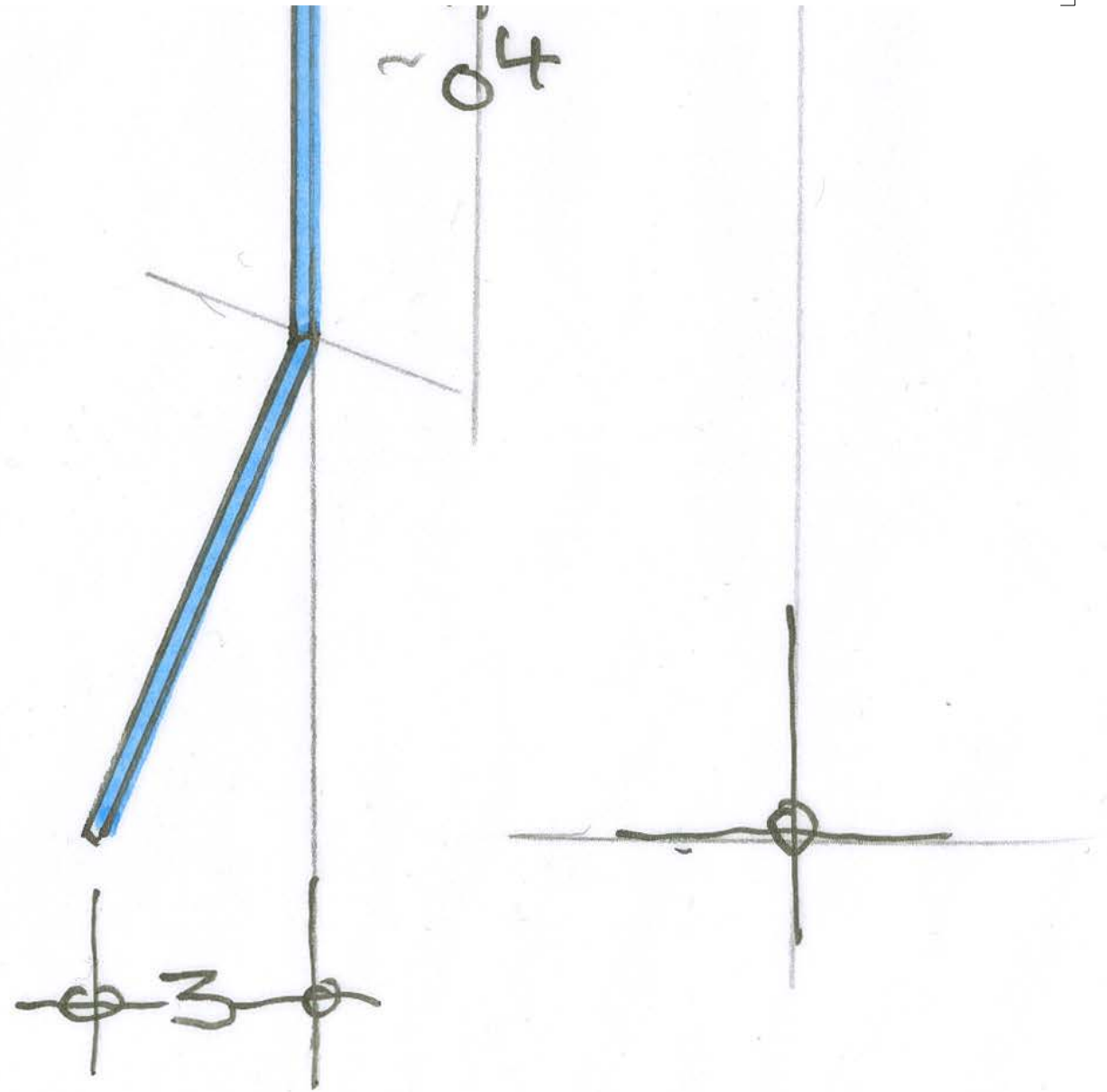

~~RUMPF/SCHNITT~~

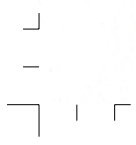

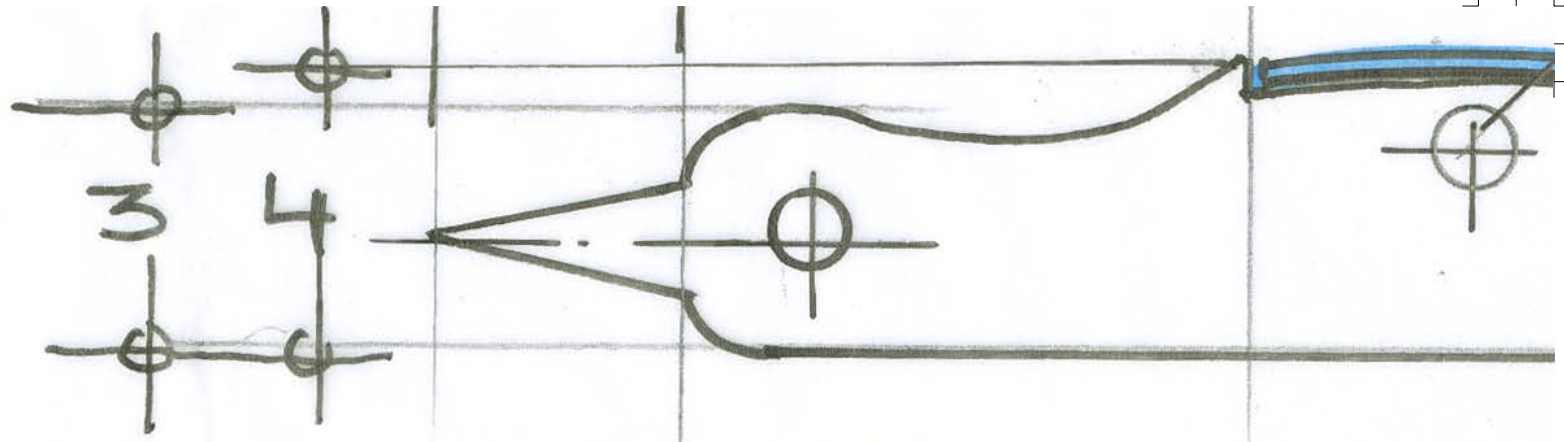

SEITENANSICHT

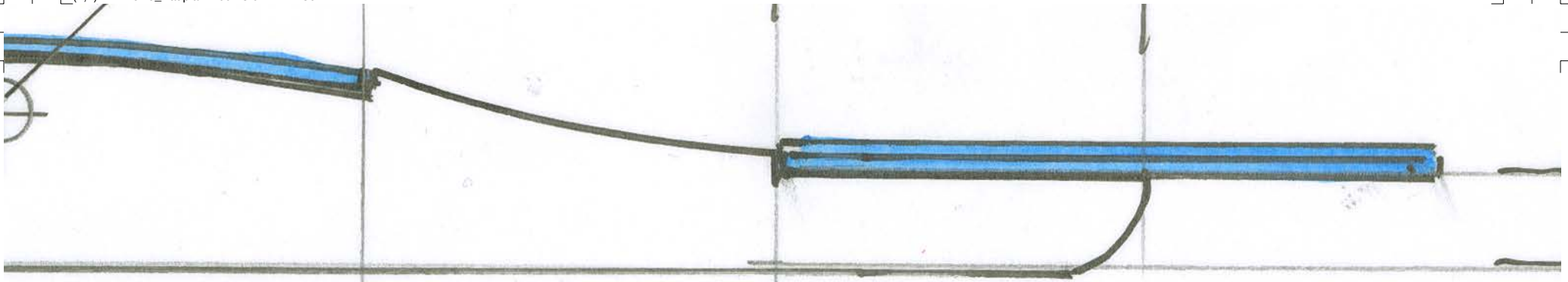

0
SICHT RUMPF 2X



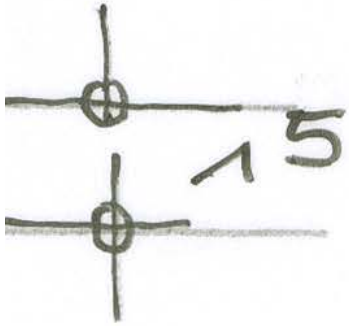

GEZ. IM MASSSTAB 1:20

BI

0